

POINTS TO CONSIDER FOR SUCCESSFUL DESIGN BEFORE INSTALLATION:

MOISTURE CONTENT

Due to the hygroscopic nature of timber, it will adjust in moisture content according to ambient changes in temperature, humidity and weather exposure. As the moisture content changes, the timber expands and contracts.

THE FOLLOWING POINTS NEED TO BE CONSIDERED:

- Local climate
- Level of exposure to direct sunlight
- Allowance for expansion on large dimensions.

LONG TERM WEATHERING

A decision needs to be made at design stage whether to maintain the colour of the timber with an oil based timber preservative applied at regular intervals, or to allow the timber to weather naturally to a soft grey colour which requires minimal maintenance.

ASPECTS FOR CONSIDERATION:

- Committal of the client to long term maintenance
- Accessibility of the façade
- Desired aesthetic effort.
- If installed above other building materials, consider that natural tannin leaching can occur, due to rain, causing stains. This can be avoided by directing runoff water away from critical surfaces. Tannin is non-corrosive and is only of aesthetic concern.

FLASHING AND WATERPROOFING

All junctions and abutments with other surfaces need to be carefully considered. Sarking in combination with battened cladding needs to be detailed by a design professional. Cedar Sales has flashings available for consideration.

IDEAL FOR:

- Exterior architectural features
- Interior architectural features
- Holiday (Eco) retreats
- Hospitality building designs.

ENVIRONMENTAL CREDENTIALS:

Cedar Sales is fully committed to supplying the building and design industry with responsibly harvested timber products from carefully managed resources.

DURABILITY CLASS:

- Western Red Cedar has a Durability Class 2
- H3 Treatment with Copper Azoles to 5mm penetration is recommended

COATING:

- We recommend Cutek External Outdoor Oil.

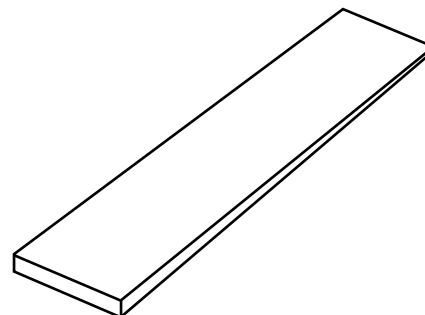

INTRODUCTION

This manual is intended for use with Western Red Cedar shingle applications only. Western Red Cedar products manufactured by CSSB members are labeled with the "Certi" brand name.

Certi-label Western Cedar shingles is the ideal exterior wall cladding for new construction and remodeling. They bring life in the form of beauty, texture, durability, insulative quality, and low maintenance to any building. Restyling with Certi-label Western Cedar shingles is easily accomplished, whether replacing the previous wall material [re-wall] or applying right over the existing wall [overwalling].

EXTERIOR AND INTERIOR WALLS CONSTRUCTION MANUAL:

Material for this manual has been compiled from various authoritative sources, and many of the construction methods shown herein have been developed by the shingle specialists in both the United States and Canada. The design and application details and methods of construction reflect current good building practice. Other options are possible but ensure that you check with your local code for approval.

The information in this manual is not intended to supersede local building codes.

CERTIGRADE® WESTERN CEDAR SHINGLES

Number 1 Blue Label®



The premium grade of shingles for sidewalls and roofs. These top-grade shingles are 100% heartwood, 100% clear and 100% edge grain.

PROFILE

Square

75 to 300mm widths



LENGTH

450mm [Requires 2/3 coverage for Blue Grade.]

CERTI-LABEL PRODUCTS

Certi-label Western Cedar shingles manufactured by members of the Cedar Shake & Shingle Bureau ["CSSB"] are the only products labeled with the "Certi" brand name. Certi-label Western Cedar shingles are made by experienced craftsmen who take pride in their trade and the quality of their product. Despite their varying sizes and sometimes remote locations, member mills are bound together by a rigid quality code. Unannounced independent inspections conducted by accredited third party agencies ensure that product quality is maintained. Products are inspected to conform with various local, national and international codes and standards [contact the CSSB for specific details].

All CSSB member product has the mill's distinctive Certi-label tucked under the bundle strap or printed on the carton. Asking for "the blue label" or "number one blue label" is not specific enough: CSSB members' products are the only ones with the Certi brand name on the label.

APPLICATION NOTES

Good workmanship is crucial to the integrity of any sidewall system. Installers should read this manual carefully and ensure that they follow proper workmanship practices. Certi-label Western Cedar shingles are applied on walls in a different manner than on roofs. The major point of difference is in permissible weather exposures - on walls the maximum weather exposure is greater than it is on roofs. A given area of wall, therefore, will require less material than the same area of roof [generally 1/2 coverage].

ROOF APPLICATION QUICK REFERENCE GUIDE

- Be sure that sarking on shakes does not extend below a line that is twice the exposure above the butt [i.e. a 610mm shake at 255mm, exposure would have felt applied 510mm above the butt].
- Keyways must not be aligned and must be a minimum 38mm offset from the course above.
- DO NOT drive nail heads or staple crowns below wood surface.
- Overdriving or underdriving the fasteners can seriously damage the integrity of your roofing system.

DESIGN AND APPLICATION DETAILS

The instructions given here are not meant to supercede local code requirements. Check with your local building official for their preference in your area.

WALL DETAILS

Preparation - Be sure that the walls are smooth, without protuberances. Nail ends or points should be removed or pounded flush.

Underlayment - Sarking and insulation as specified.

Corner Boards - Install corner boards at this time.

Flashing - Flashings associated with doors, windows, and penetration details should be in accordance with good building practice.

Laying Out - Determine the number of Certi-label courses by measuring the height of the wall at the lowest part of the slab, from a point 25mm below the top of the slab, to the top of the wall. Divide the height into equal parts, corresponding closely to the weather exposure, but not exceeding the maximum weather exposure recommended. Transfer this measurement and the number of Certi-label courses to a storypole to lay out courses on all other walls. Whenever possible butt lines should align with tops or bottoms of windows or other openings, and for appearance the exposure of the final course at the top should match those below.

Certi-label Western Cedar shingle size, exposure, width of joints, width of product, kiln versus air-drying process, moisture content and the local environment will all affect the expansion/contraction of Certi-label Western Cedar sidewall products. These factors should always be taken into consideration when determining the installation details and adequate spacing needed for your specific project. Consult with your installer and refer to Figure 1: Spacing Detail.

Figure 1: Spacing Detail

Number 1 Grade Certi-label Western Red Cedar shingles shall be spaced 3mm to 6mm apart (keyways are 3 to 6mm wide). These joints allow for expansion and prevent possible "buckling." For every 100mm width of dry Certi-label Western Cedar shingle material, the product will expand approximately 3mm. Therefore space keyways accordingly, i.e.305mm shingle is expected to have approximately 10mm expansion.

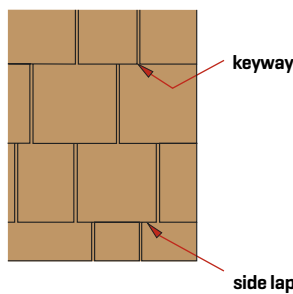

Leave a side lap of at least 38mm between joints in successive courses.

NAILS

Each Certi-label™ Western Cedar shingle should be applied with two fasteners. Nails **must be** stainless steel **Type 316** in locations within coastal regions. For locations outside the salt water zone - nails **must be** stainless steel **Type 304, Type 316**, or hot-dipped zinc coated galvanized. Stainless steel nails, although more expensive, offer the highest degree of corrosion resistance. Contact a nail manufacturer for further information to ensure the nails used comply with listed requirements and are correct for your application. Minimum nail lengths are shown in the fastener chart below.

Single Course Sidewall Fasteners	
Product Type	Nail Type & Minimum Length
Certigrade Shingles	Type
450mm Shingles	3d Box 32mm

Certi-label™ Western Cedar shingles wider than 255mm require 2 additional nails and these two nails are driven approximately 25mm apart near the center of the shingle.

Figure 2: Wide Shingle Fastener detail

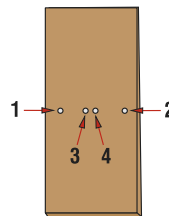

Figure 3: Nail Driving detail

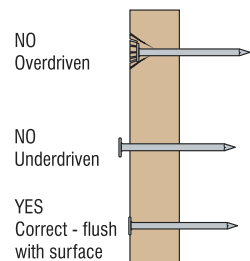
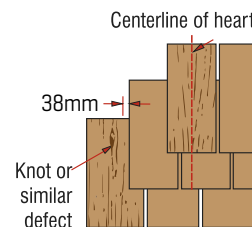

Figure 4: Course Alignment



STAPLES

If you choose to use staples they **must be** stainless steel **Type 316** in locations within coastal regions. For locations outside of the salt water zone - stainless steel staples **Type 304** or **Type 316 must be** used. Two staples should be driven per Certi-label™ Western Cedar shingle with the staple crowns 11mm minimum horizontal, maximum 19mm horizontal, to the Certi-label Western Cedar™ shingle butt. Staples are driven in the same location as nails relative to the sides and overlapping butt line. Certi-label™ Western Cedar shingles wider than 255mm require 2 additional staples and these two staples are driven approximately 25mm apart near the center of the shingle.

Fasteners should be long enough to penetrate into the sarking at least 19mm or all the way through and driven flush with the surface of the Certi-label™ Western Cedar shingle. In all applications, staples shall be concealed by the course above.

DO NOT USE ELECTRO-GALVANIZED (EG) FASTENERS. Ensure the fasteners used comply with listed requirements. Nails are preferred, for aesthetic reasons, in sidewall application using exposed fasteners.

SINGLE COURSING

Double the starting course at the base of the wall. For Number 1 Grade Certi-label Western Red Cedar shingles apply with 3mm to 6mm keyway space, giving a pronounced individual effect to each course. Offset the side joints in any one course at least 38mm over joints in adjacent courses.

Use a straight edge, nailing it lightly to the wall with the edge at the butt line (to keep courses straight and level). Check for level every 3 or 4 courses. This wall application features concealed nailing (refer to Figure 5), with nails driven approximately 25mm above the butt line of the succeeding course. With Certi-label Western Cedar shingles wider than 255mm, drive two additional nails approximately 25mm apart near the center.

Because Certi-label Western Cedar shingles vary in width there should be little waste. At corners, or at door or window frames, you may have to trim a selected Certi-label Western Cedar shingle slightly.

We recommend installing over plywood panel or dimensional lumber sheathing. If other sheathing materials are approved for use by your local building official, the holding power of the fasteners should also be considered carefully.

Figure 5: Single Coursing

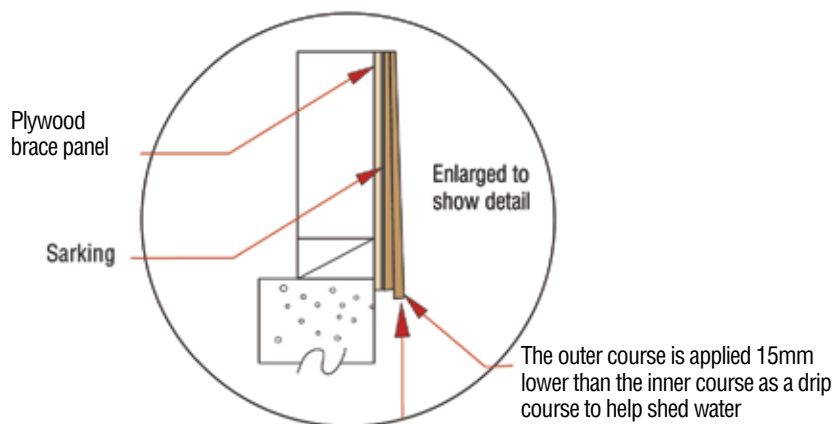

ROOF DETAILS

UNDERLAY & BATTEN

Shingles may be applied over spaced sheathing. Spaced battens are usually 25 x 100 mm or 25 x 150 mm softwood boards and shall not be less than 25 x 100 mm boards. Solid sheathing is recommended for shakes and may be required in seismic regions or under treated shingles.

Solid underlay is used in areas with high winds. Please note that the only solid sheet sheathing tested with Certi-label® Shingles is plywood. Check with your local building official for plywood thickness/dimensions. Eave protection is used on the edge where 915mm felt underlay is used and should extend up at least 610mm beyond the exterior wall but it is not meant to cover the entire roof.

STAGGERED BUTT APPLICATIONS

Staggered butt applications are made by shortening the exposure less than the greater maximum exposure. No shingles shall be applied greater than the maximum exposure allowed. Check with local building codes for approval of this installation method.

Note: Consult an Engineer for sizing. Do not cover the entire deck with non-permeable barrier (including nonpermeable underlayment). Timber needs to breath.

VENTILATION GUIDELINES

The importance of good roof ventilation beneath the roof cannot be overemphasized. Such movement of air will prevent or inhibit condensation of moisture on the undersurface of the Certi-label® shingles, or on the roof. Vents should be provided at the soffits (eaves) as well as at gable ends (screened to prevent ingress of insects), on roof by using attic roof ventilation or preferably the ridge lines with cross-ventilation desirable. A rule of thumb for adequate ventilation is that the ratio of total net free ventilation area to the area of the roof should be not less than 1:150, with compensation made for screens over vent apertures. Check with your local building department. Attic fans may be beneficial by supplying additional movement of air in roof spaces.

Any modification to the vapor barrier system or addition of a vapor barrier system should only be done after consulting with your local building official or a building envelope specialist. In some areas, building envelope specialists are regulated by government. Please check with local building officials to see if there are professional requirements in your area.

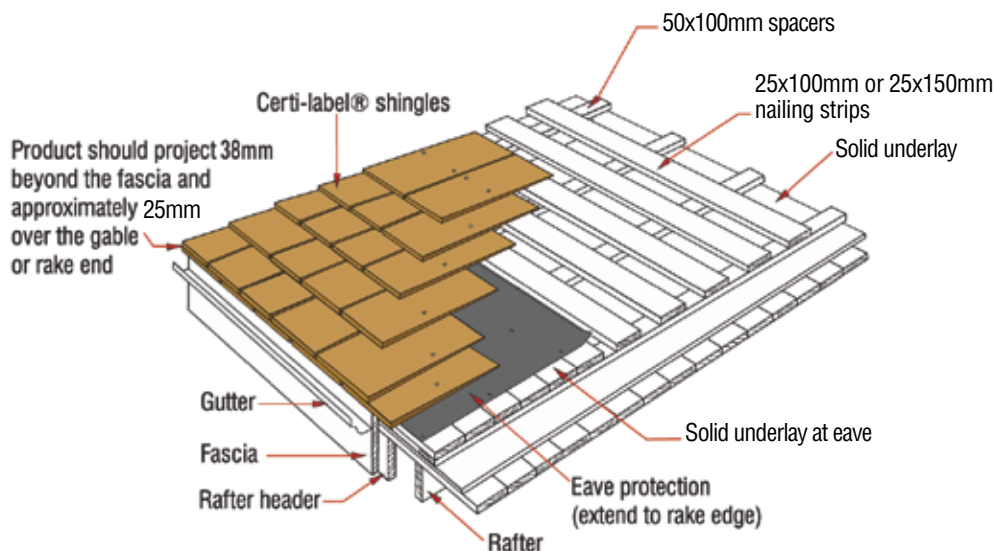

Installation instructions

SHINGLE

In areas of high humidity where solid underlay is required:

Following are 4 different suggested methods of application to increase longevity:

1. Apply impregnated treatment to shingles.
2. Apply vertical strips over the underlay in alignment with the rafters below, then place horizontal furring strips on top of the vertical boards.
3. Apply horizontal battens to the underlay.
4. A continuous ventilation product may be used beneath roofing material. Continuous Ventilation Products come in a variety of designs/formats, consult your supplier.*

Note: Good ventilation is essential. Ridge and soffit vents are recommended.

